



Product Type: Low-voltage High-current Connector

Product Name:EA60PHF230G-OG

Product Description: Connectors for Drones and Embodied Intelligence:Color:Orange,Rated current:35A,Rated voltage(III/3)250V,Rated impulse voltage1000V,Product type:Straight female connector for Board,Welding leg specifications:3mm,Cross-section:12AWG,Pins:2-Pin,Contact plating:Au,Plated

Product Size

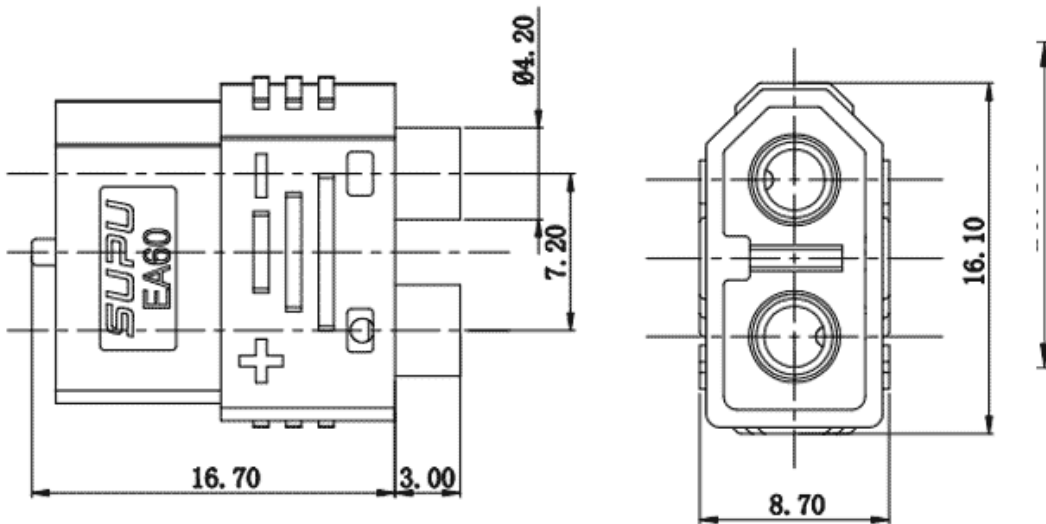

Parameters

☞ Pitch	7.2
☞ Connection method	Welded
☞ Protection Level	IP40
☞ Operating temperature range	-40°C~125°C
☞ Insulation material	PA
☞ Insulation material group	I
☞ Contact material	Copper Alloy
☞ Contact plating	Au,Plated
☞ Insertion/withdrawal cycles	100
☞ 塑件结构	board
☞ 焊脚规格	3mm
☞ Outgoing direction	Horizontal Wiring

Technical data

☞ Rated Voltage	250V
☞ Overvoltage category	III
☞ Degree of pollution	3
☞ Rated impulse voltage	1000V

Commercial data

☞ Order No	EA60PHF230G-OG
------------	----------------

Address: No. 150, Xinxing 4th Road, High-tech Industrial Development Zone,

Cixi City, Zhejiang Province, China

Zip code: 315303

Switchboard: +86 574-63288158

Fax: +86 574-63288170

E-mail:supucontact@supu.cn

Service Hotline: 400-626-6336



Wechat

Date:2026-04-27 14:00

The right to modify data belongs to SUPU.