

Product Type: Plug-in terminal-Plug

Product Name:MC-
DRG3.5H26P-K-0001

Product Description: Pitch:3.81mm Rated Voltage : 160V Rated Current:13.5A Connection method : Push in connection colour : customizable

Product Size

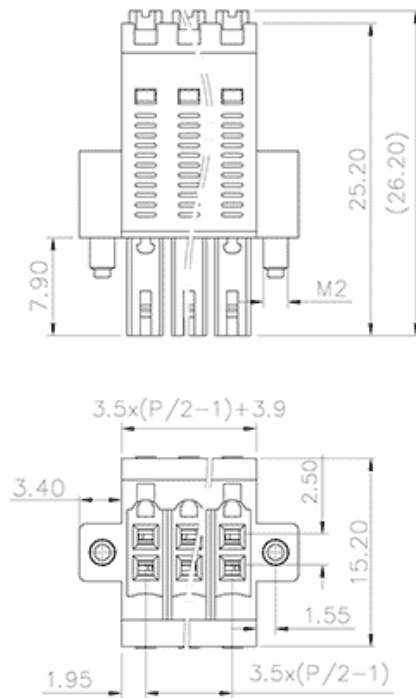

Parameters

⌘ SUPU ID	MC-DRG3.5H26P-K-0001
⌘ Pitch	3.5
⌘ Number of levels	double-layer
⌘ Number of connections	26

☞ Connection method	Push in connection
☞ Protection Level	IP20
☞ Operating temperature range	-40~+105°C
☞ Insulation material	PA66
☞ Insulation material group	I
☞ Contact material	Copper alloy
☞ Contact plating	Sn,Plated
☞ Color	Green/Black/Blue/Grey/Orange/Red

Technical data

☞ IEC Rated Current	13.5A
☞ IEC Rated Voltage	160V
☞ Overvoltage category	III/III/ II
☞ Degree of pollution	3 2 2
☞ Rated impulse voltage	2.5KV 2.5KV 2.5KV
☞ UL Rated Current	10A - 10A
☞ UL Rated Voltage	300V - 300V
☞ Conductor cross section rigid	0.2-1.5mm ²
☞ Conductor cross section flexible	0.2-1.5mm ²
☞ Conductor cross section flexible,with ferrule	0.2-1.5mm ²
☞ Locking screw Specification	-
☞ Locking screw torque	-
☞ Fixed Screw Specification	M2.0
☞ 固定螺钉扭矩	0.2N·m

☞ Stripping length	8-9mm
☞ Use group	B/C/D
☞ Rated cross section	24~16AWG

Commercial data

☞ Order No	MC-DRG3.5H26P-K-0001
------------	----------------------

Ningbo SUPU Electronics Co., Ltd.

Address: No. 150, Xinxing 4th Road, High-tech Industrial Development Zone,
Cixi City, Zhejiang Province, China

Zip code: 315303

Switchboard: +86 574-63288158

Fax: +86 574-63288170

E-mail:supucontact@supu.cn

Service Hotline: 400-626-6336



Wechat