



Product Type: Plug-in terminal-Socket

Product Name:MC-PC5.08V04C-BF-0001

Product Description: Pitch: 5.08mm Rated Voltage : 320V Rated Current: 12A Connection method : Screw connection colour : customizable

Product Size

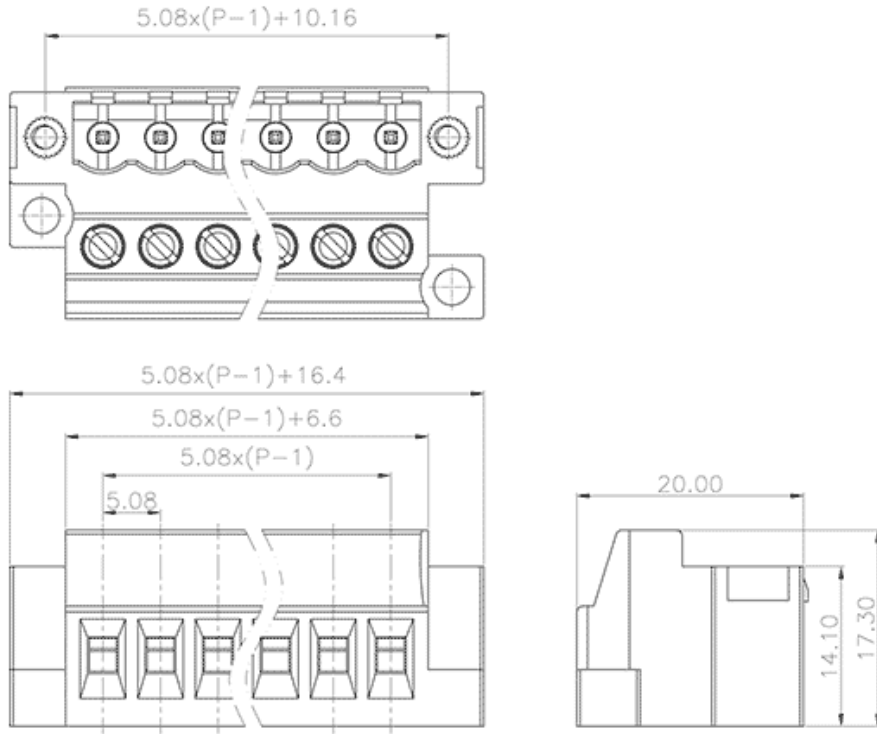

Parameters

| | |
|-------------------------|-----------------------|
| ☞ SUPU ID | MC-PC5.08V04C-BF-0001 |
| ☞ Pitch | 5.08 |
| ☞ Number of levels | Single layer |
| ☞ Number of connections | 4 |

| | |
|-------------------------------|----------------------------------|
| ☞ Connection method | Screw connection |
| ☞ Protection Level | IP20 |
| ☞ Operating temperature range | -40~+105°C |
| ☞ Insulation material | PA66 |
| ☞ Insulation material group | I |
| ☞ Contact material | Copper alloy |
| ☞ Contact plating | Sn,Plated |
| ☞ Color | Green/Black/Blue/Grey/Orange/Red |

Technical data

| | |
|---|------------------------|
| ☞ IEC Rated Current | 320V |
| ☞ IEC Rated Voltage | 12A |
| ☞ Overvoltage category | III III II |
| ☞ Degree of pollution | 3 2 2 |
| ☞ Rated impulse voltage | 4.0KV 4.0KV 4.0KV |
| ☞ UL Rated Current | 15A - 10A |
| ☞ UL Rated Voltage | 300V - 300V |
| ☞ Conductor cross section rigid | 0.2-2.5mm ² |
| ☞ Conductor cross section flexible | 0.2-2.5mm ² |
| ☞ Conductor cross section flexible,with ferrule | 0.2-2.5mm ² |
| ☞ Locking screw Specification | M3 |
| ☞ Locking screw torque | 0.5-0.6N.m |
| ☞ Stripping length | 7-8mm |
| ☞ Use group | B/C/D |

Commercial data

☞ Order No

MC-PC5.08V04C-BF-0001

Ningbo SUPU Electronics Co., Ltd.

Address: No. 150, Xinxing 4th Road, High-tech Industrial Development Zone,
Cixi City, Zhejiang Province, China

Zip code: 315303

Switchboard: +86 574-63288158

Fax: +86 574-63288170

E-mail:supucontact@supu.cn

Service Hotline: 400-626-6336



Wechat