



Product Type: M8 Panel Mounting Connector

Product Name: M8A06C-FPSRHUC

Product Description: M12A panel female 6-core welded type, board mounted, M8*0.75

Product Size

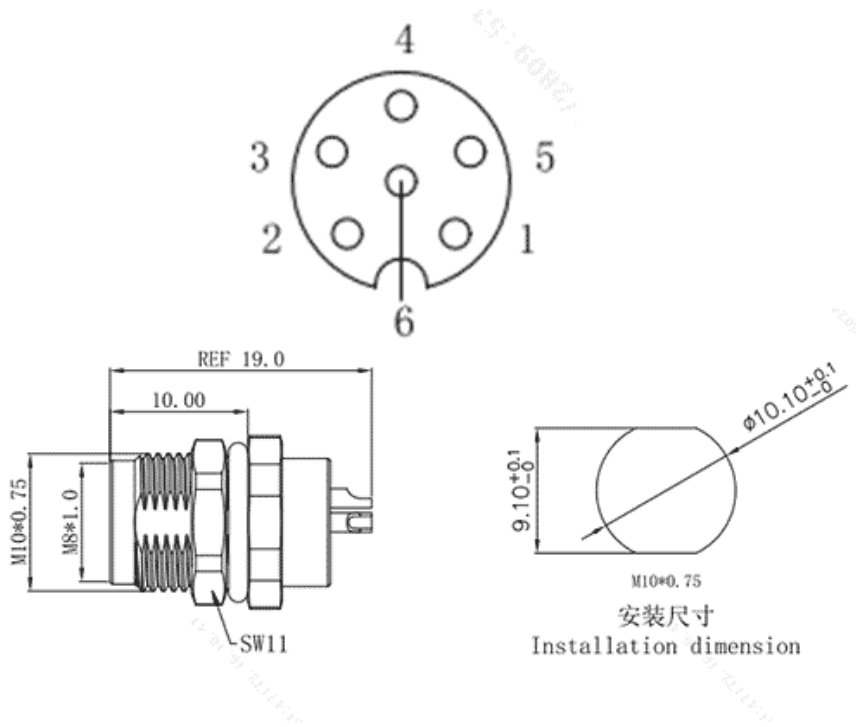

Parameters

| | |
|-------------------------------|-----------|
| ☞ SUPU ID | M8 |
| ☞ Number of connections | 6 |
| ☞ Protection Level | IP67 |
| ☞ Operating temperature range | -40~+85°C |

| | |
|------------------------|----------------|
| ☞ Mounting Type | Rear Mounting |
| ☞ Color | Black |
| ☞ Core number | 6 |
| ☞ Thread type | M8X0.75 |
| ☞ Category | Female |
| ☞ Product type | A |
| ☞ Coding | A |
| ☞ Connection method | Cup Port |
| ☞ Mechanical endurance | 100 |
| ☞ Standards | IEC61076-2-104 |

Technical data

| | |
|----------------------------|-----------------|
| ☞ IEC Rated Current | 1.5A |
| ☞ IEC Rated Voltage | 30 VAC / 30 VDC |
| ☞ Degree of pollution | 3 |
| ☞ Insulation Resistance | ≥100MΩ |
| ☞ Contact resistance | <10mΩ |
| ☞ Contact/surface material | CuSn/Ni/Au |
| ☞ Contact carrier material | PA |
| ☞ Screw/nut material | CuZn |
| ☞ Sealing material | NBR |
| ☞ Cable length | / |
| ☞ 导线材料 | / |

Commercial data

☞ Order No

M8A06C-FPSRHUC

☞ Packing unit

PCS

☞ Minimum order quantity

1

Ningbo SUPU Electronics Co., Ltd.

Address: No. 150, Xinxing 4th Road, High-tech Industrial Development Zone,

Cixi City, Zhejiang Province, China

Zip code: 315303

Switchboard: +86 574-63288158

Fax: +86 574-63288170

E-mail:supucontact@supu.cn

Service Hotline: 400-626-6336



Wechat

Date:2026-06-11 04:43

The right to modify data belongs to SUPU.