

Product Type: Heavy-duty Connector Housing

Product Name: S24B-SM-2L.M-2M25

Product Description: S24B Housings, metal, 2 levers, surface mounting, 2xM25 thread

Product Size

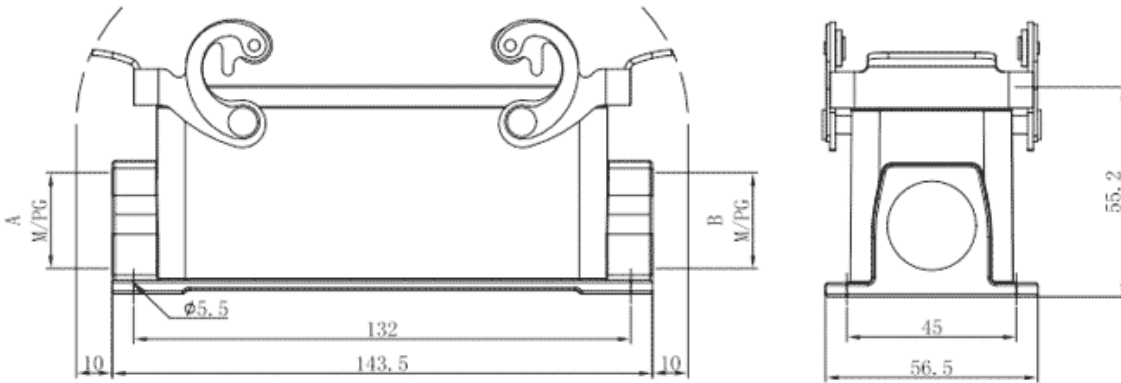

Parameters

☞ SUPU ID	S24B-SM-2L.M-2M25
☞ Protection Level	IP65
☞ Operating temperature range	-40°C~+125°C
☞ Color	Grey

☞ Thread type	M25
☞ Category	Base
☞ Mechanical endurance	≥500

Technical data

☞ Sealing material	NBR
☞ Housing Material	Die-Cast Aluminum

Commercial data

☞ Order No	S24B-SM-2L.M-2M25
☞ Packing unit	PCS
☞ Minimum order quantity	1

Ningbo SUPU Electronics Co., Ltd.

Address: No. 150, Xinxing 4th Road, High-tech Industrial Development Zone,

Cixi City, Zhejiang Province, China

Zip code: 315303

Switchboard: +86 574-63288158

Fax: +86 574-63288170

E-mail: supucontact@supu.cn

Service Hotline: 400-626-6336



Wechat

Date:2026-04-27 04:00

The right to modify data belongs to SUPU.