



Product Type: Heavy-duty Connector Housing

Product Name: S10B-CCH-1L.M-M32

Product Description: S10B Housings, metal, 1 levers, cable to cable, high construction, M32 thread

Product Size

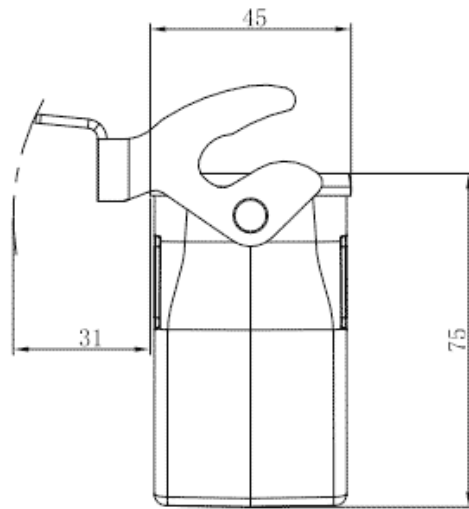
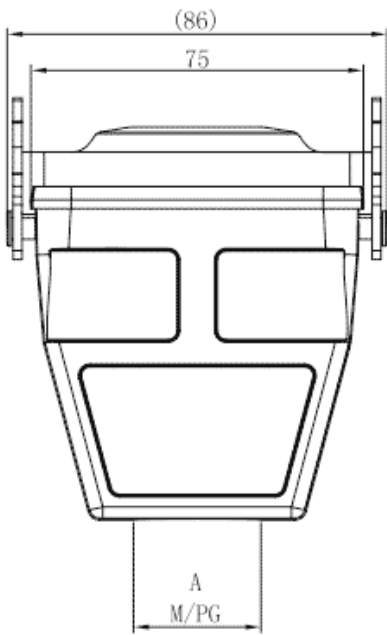

Parameters

☞ SUPU ID	S10B-CCH-1L.M-M32
☞ Protection Level	IP65
☞ Operating temperature range	-40°C~+125°C
☞ Color	Grey

☞ Thread type	M32
☞ Category	Base
☞ Mechanical endurance	≥500

Technical data

☞ Sealing material	NBR
☞ Housing Material	Die-Cast Aluminum

Commercial data

☞ Order No	S10B-CCH-1L.M-M32
☞ Packing unit	PCS
☞ Minimum order quantity	1

Ningbo SUPU Electronics Co., Ltd.

Address: No. 150, Xinxing 4th Road, High-tech Industrial Development Zone,

Cixi City, Zhejiang Province, China

Zip code: 315303

Switchboard: +86 574-63288158

Fax: +86 574-63288170

E-mail: supucontact@supu.cn

Service Hotline: 400-626-6336



Wechat

Date:2026-04-25 22:45

The right to modify data belongs to SUPU.