

Product Type: Heavy-duty connector pins

Product Name:SCSF-016-2.5

Product Description: 16A silver plated,Female,compatible with 2.5mm²

Product Size

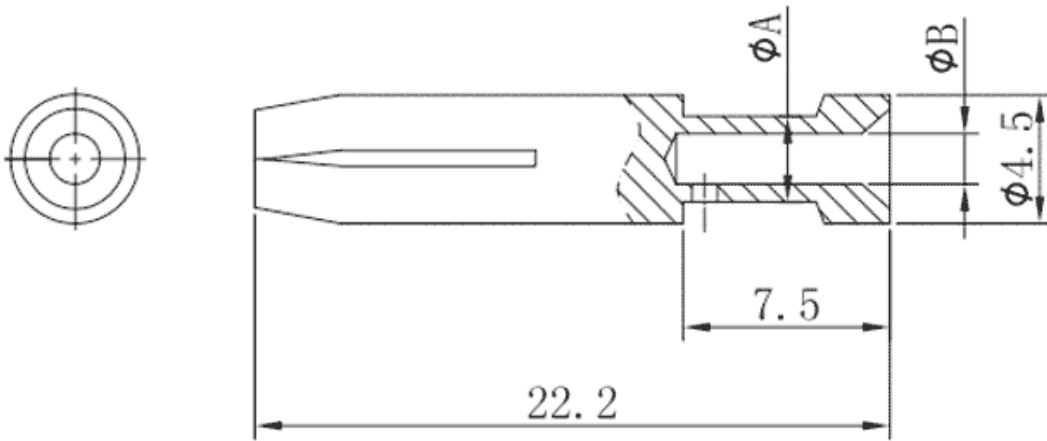

Parameters

☞ SUPU ID	SCSF-016-2.5
☞ Operating temperature range	-40°C~+125°C
☞ Category	cold-pressed pin female terminal
☞ Connection method	Crimp terminal

☞ Mechanical endurance

≥500

Technical data

☞ IEC Rated Current

16A

☞ Contact/surface material

Hard-silver Plated

☞ Pin Material

Copper Alloy

☞ Contact resistance

≤1mΩ

☞ Wire Specification

2.5mm²/14AWG

Commercial data

☞ Order No

SCSF-016-2.5

☞ Packing unit

PCS

☞ Minimum order quantity

1

Ningbo SUPU Electronics Co., Ltd.

Address: No. 150, Xinxing 4th Road, High-tech Industrial Development Zone,
Cixi City, Zhejiang Province, China

Zip code: 315303

Switchboard: +86 574-63288158

Fax: +86 574-63288170

E-mail:supucontact@supu.cn

Service Hotline: 400-626-6336



Wechat

Date:2026-06-11 03:19

The right to modify data belongs to SUPU.