

Product Type: Crimp terminal

Product Name:MC-
RB5.08HXXB-K-0001

Product Description: Pitch:5.08mm Rated
Voltage : 320V Connection method : Cold
connection

Product Size

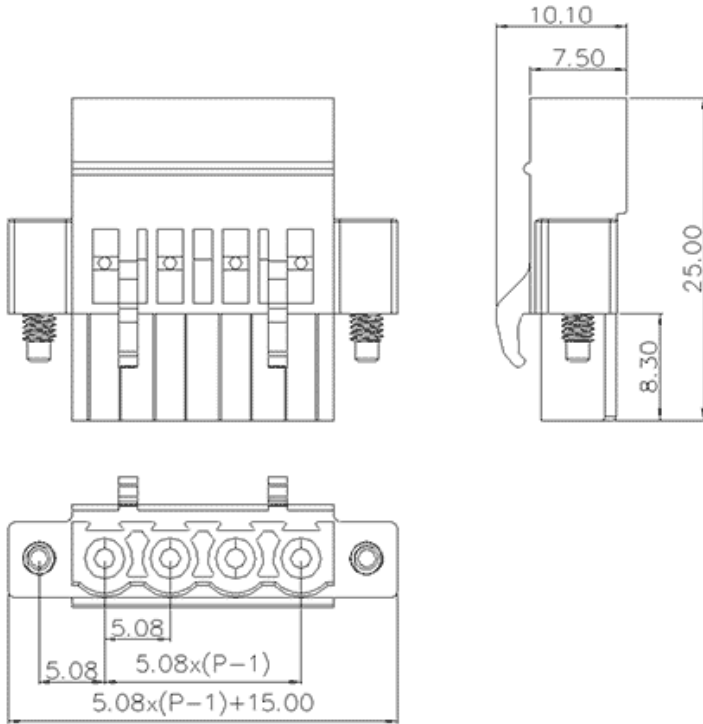

Parameters

⌘ SUPU ID	MC-RB5.08H02B-K-0001
⌘ Pitch	5.08
⌘ Number of levels	Single layer
⌘ Number of connections	XX

☞ Connection method	Cold Pressure Wiring
☞ Protection Level	IP20
☞ Operating temperature range	-40~+105°C
☞ Insulation material	PA66
☞ Insulation material group	I
☞ Contact material	Copper alloy
☞ Contact plating	Sn,Plated
☞ Color	Green

Commercial data

☞ Order No	MC-RB5.08H02B-K-0001
------------	----------------------

Ningbo SUPU Electronics Co., Ltd.

Address: No. 150, Xinxing 4th Road, High-tech Industrial Development Zone,

Cixi City, Zhejiang Province, China

Zip code: 315303

Switchboard: +86 574-63288158

Fax: +86 574-63288170

E-mail:supucontact@supu.cn

Service Hotline: 400-626-6336



Date:2026-06-13 13:19

The right to modify data belongs to SUPU.