

Product Type: Bolt Connection

Product Name:TBV10-3-GY

Product Description: Connection method:Bolt connection,IEC Rated Current:269A,IEC Rated Voltage:1000V,Number of connections:3,Number of levels:1

Product Size

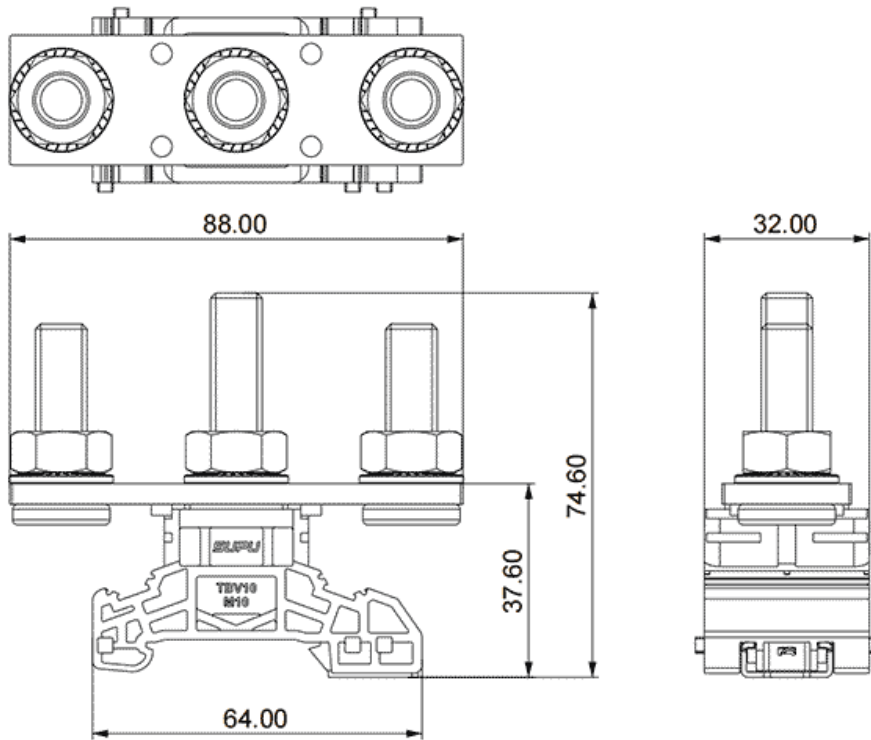

Parameters

⌘ SUPU ID	TBV10-3-GY
⌘ Width	32mm
⌘ Number of levels	1
⌘ Number of connections	3

☞ Connection method	Bolt connection
☞ Protection Level	IP20
☞ Insulation material	PA66
☞ Insulation material group	I
☞ Ambient temperature (operation)	-40°C~105°C
☞ Ambient temperature (assembly)	-5°C~70°C
☞ Ambient temperature (storage)	-25°C~60°C
☞ Permissible humidity (storage/transport)	30%~70%

Technical data

☞ IEC Rated Current	269A
☞ IEC Rated Voltage	1000V
☞ Overvoltage category	III
☞ Degree of pollution	3
☞ Rated impulse voltage	8KV
☞ Conductor cross section flexible	6-120mm ²
☞ Locking screw Specification	M10
☞ Locking screw torque	10-20N.m
☞ Use group	B/C/D
☞ Rated cross section	10AWG-250 kcmil
☞ UL Rated Current	-/269A/-
☞ UL Rated Current	-/1000V/-

Commercial data

Ningbo SUPU Electronics Co., Ltd.

Address: No. 150, Xinxing 4th Road, High-tech Industrial Development Zone,
Cixi City, Zhejiang Province, China

Zip code: 315303

Switchboard: +86 574-63288158

Fax: +86 574-63288170

E-mail:supucontact@supu.cn

Service Hotline: 400-626-6336



Wechat